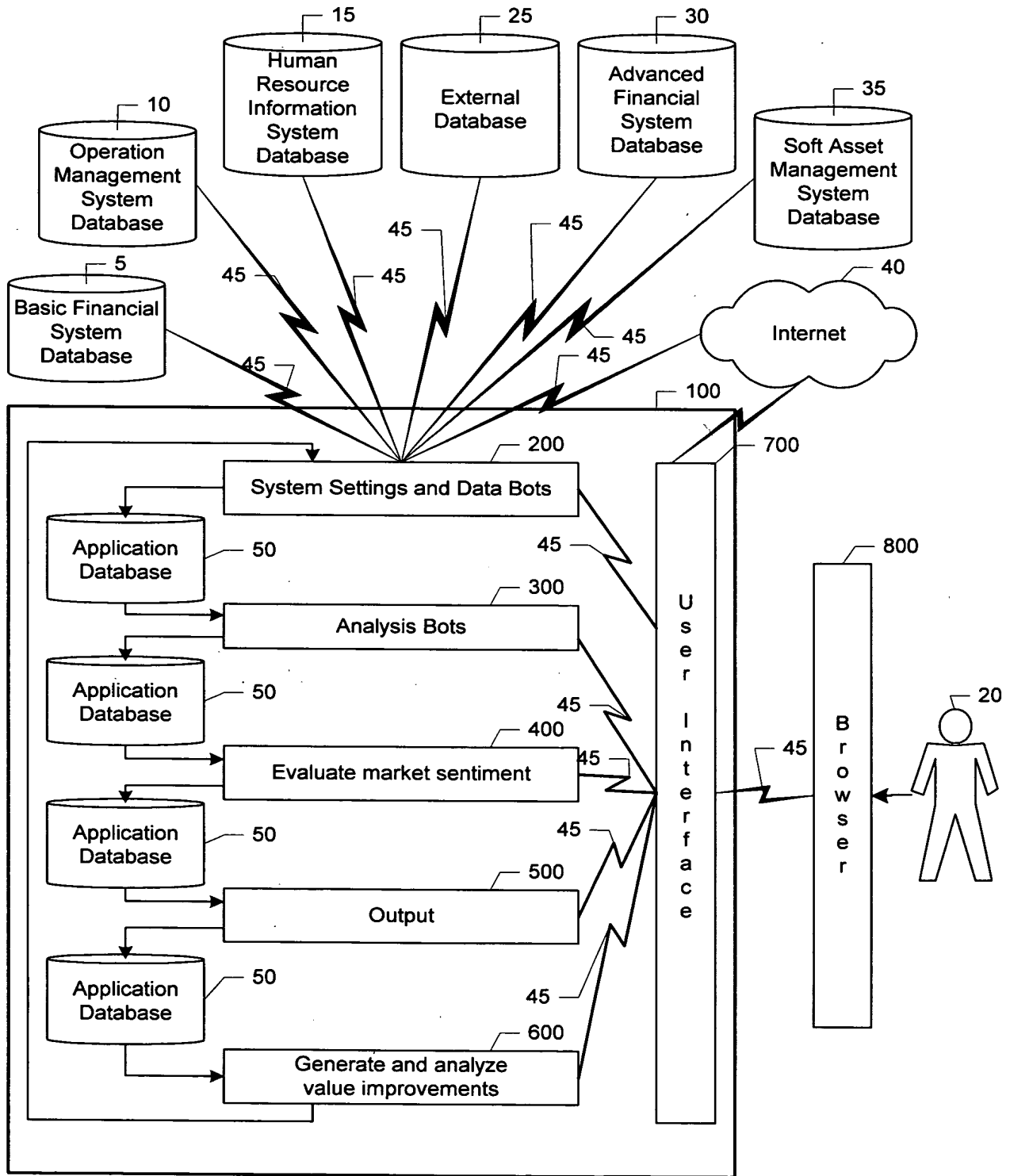
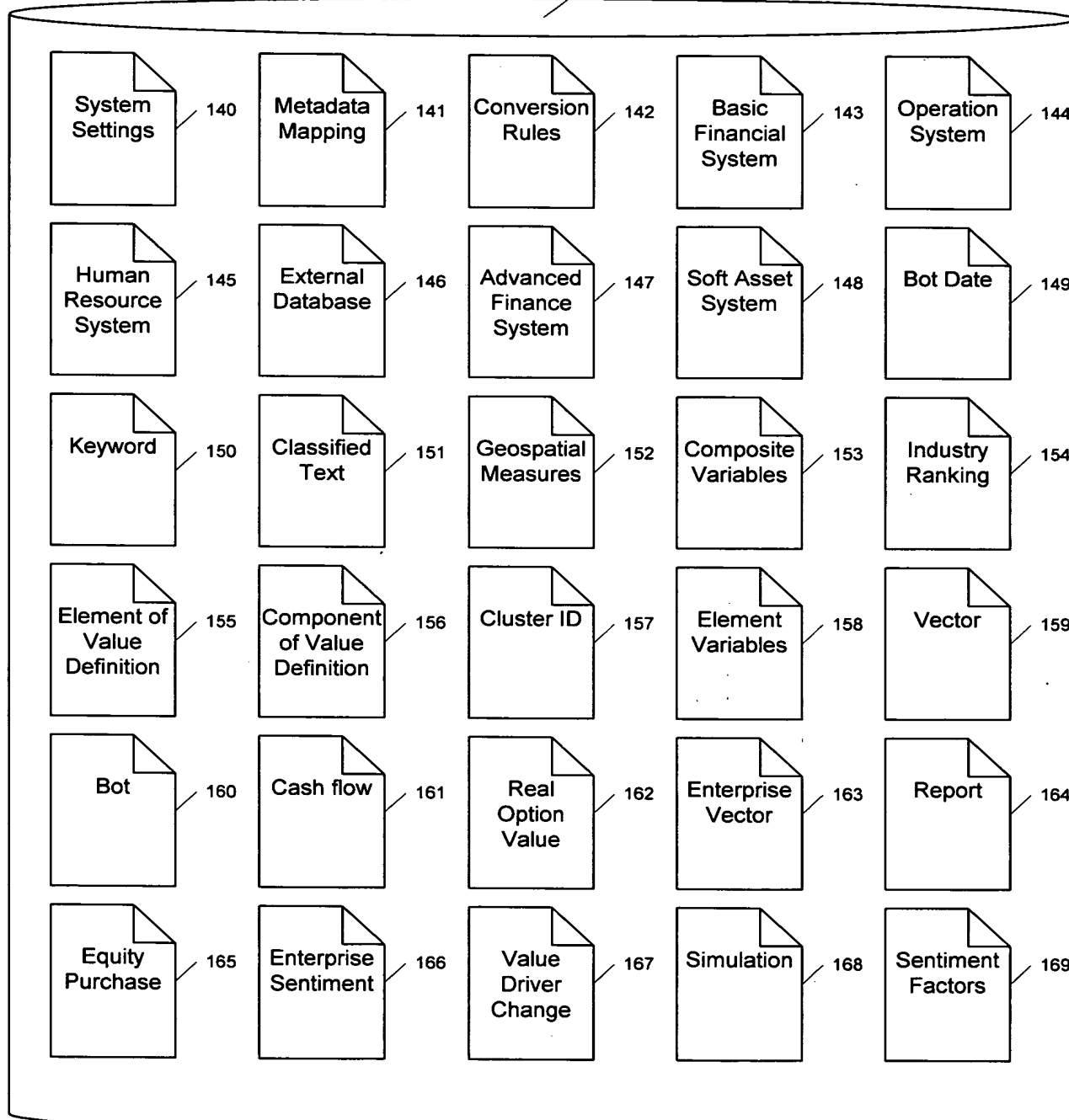


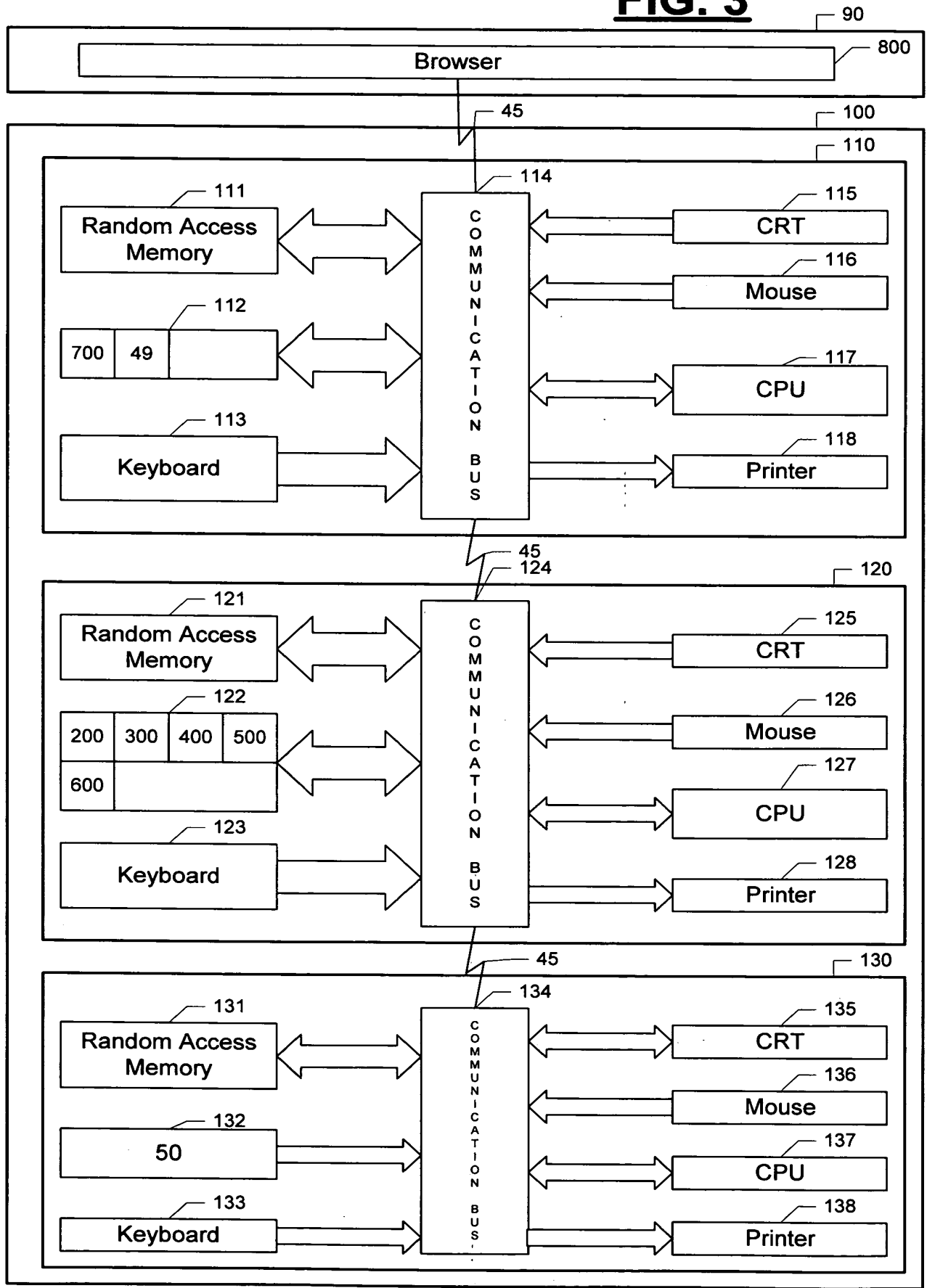
**FIG. 1**



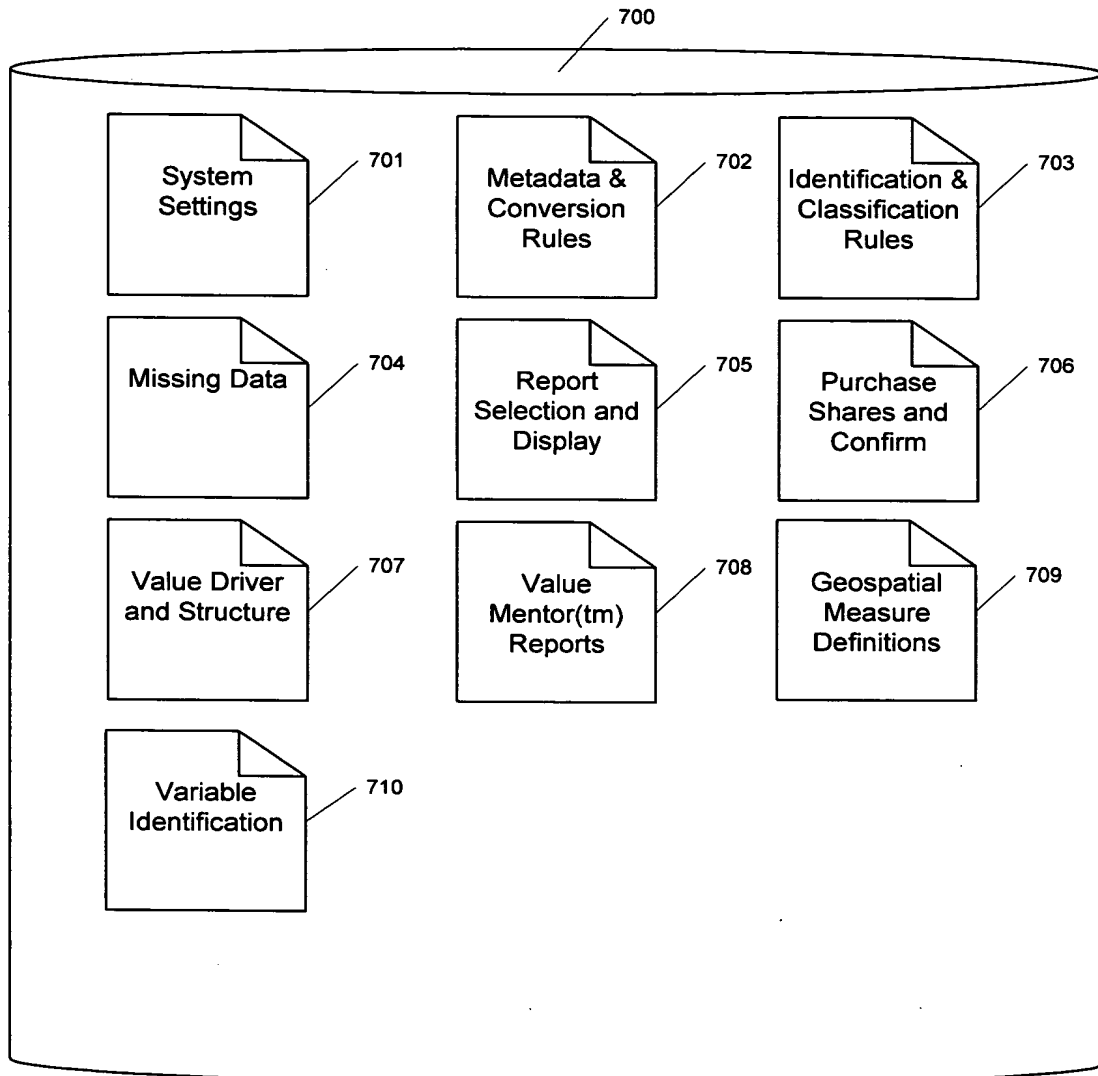
**FIG. 2**



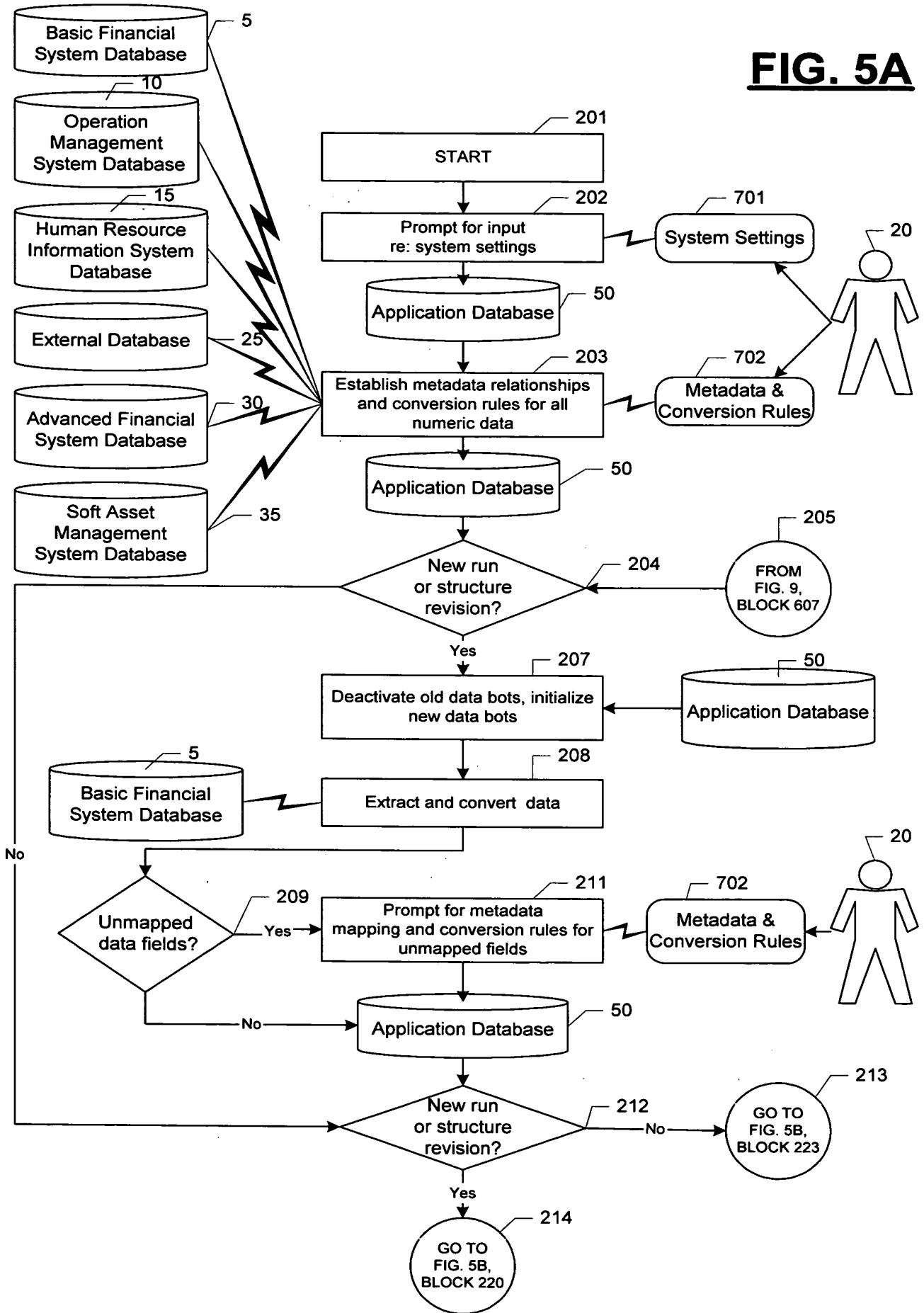
**FIG. 3**



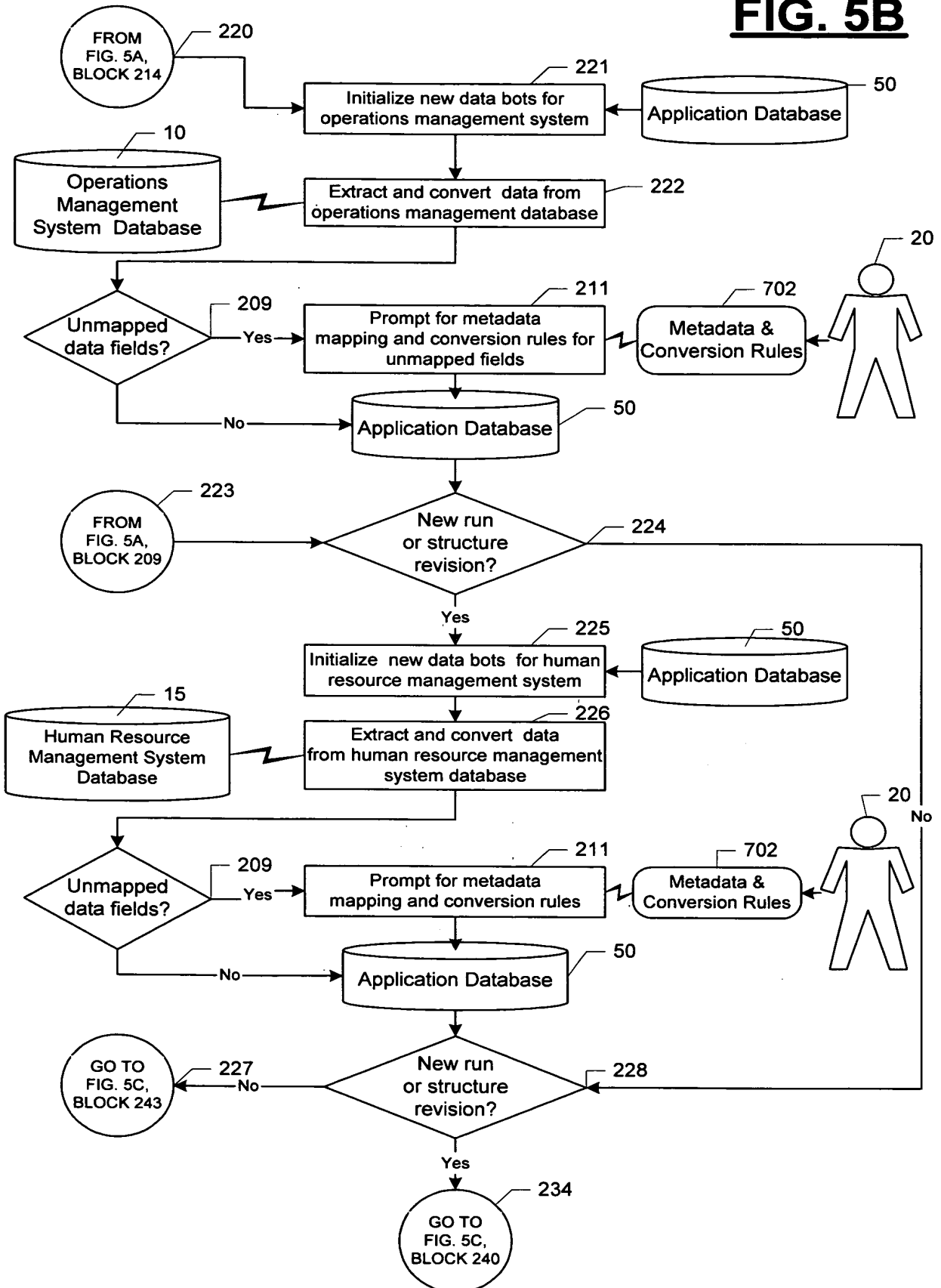
**FIG. 4**



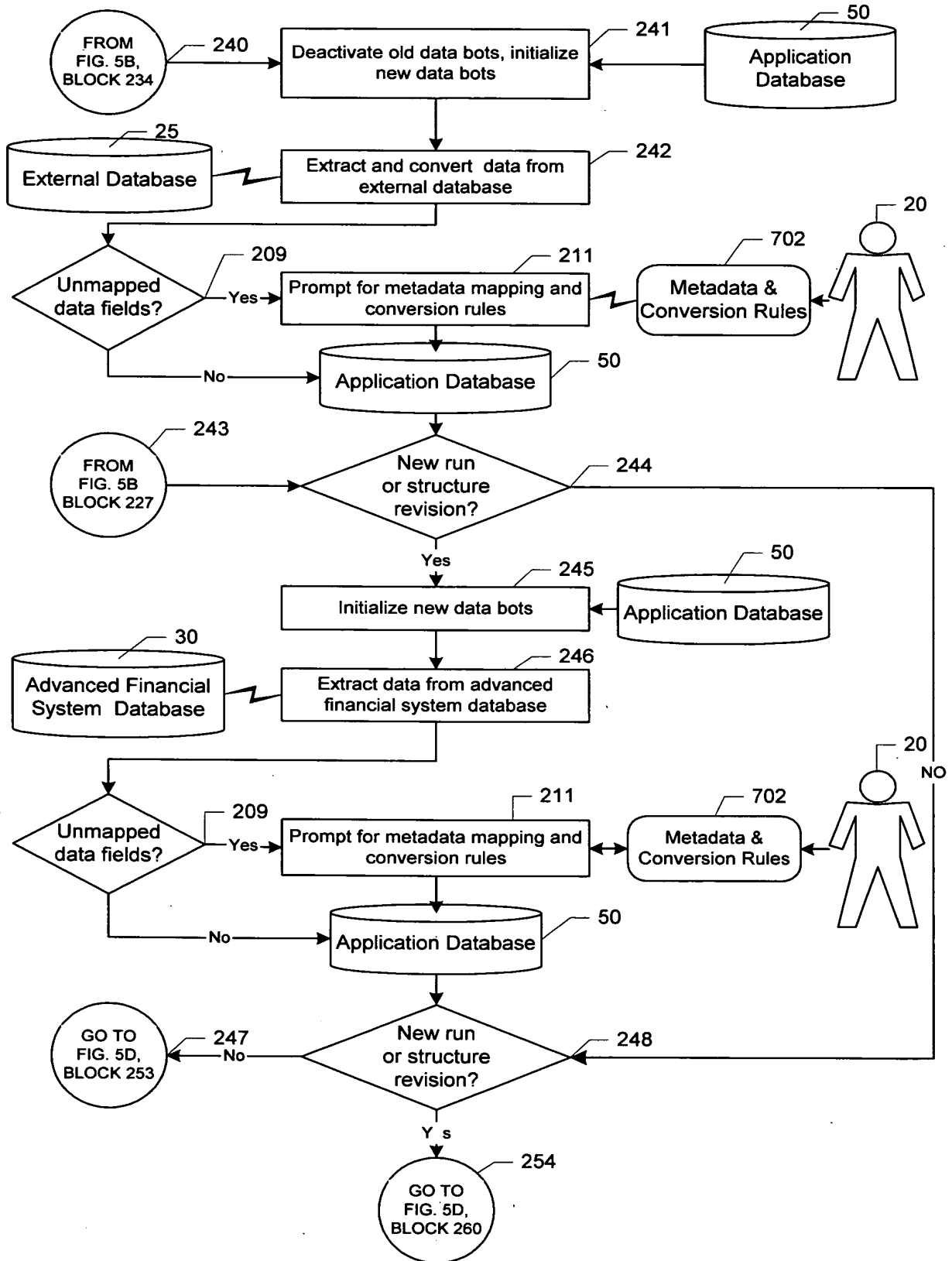
**FIG. 5A**



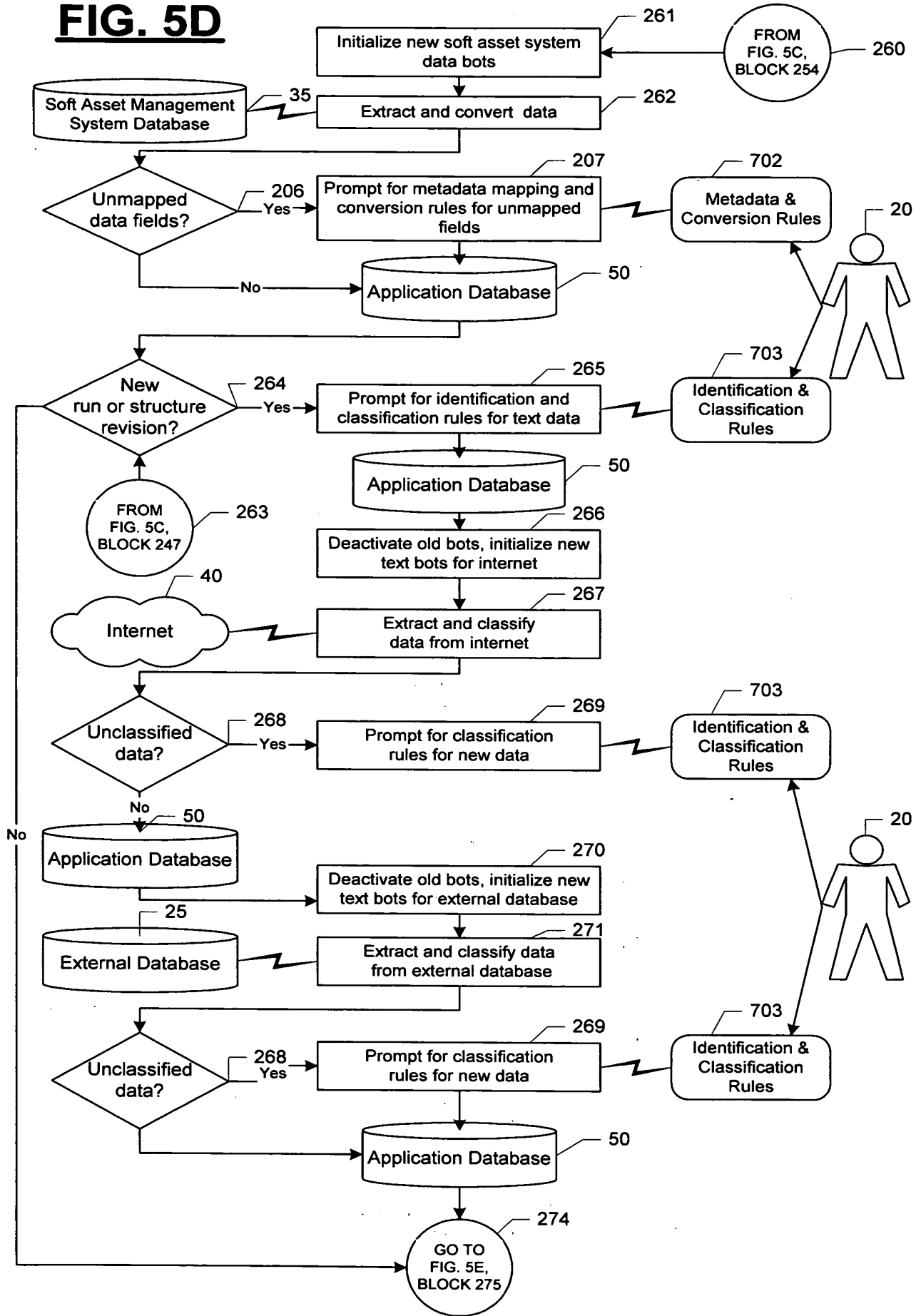
**FIG. 5B**



**FIG. 5C**

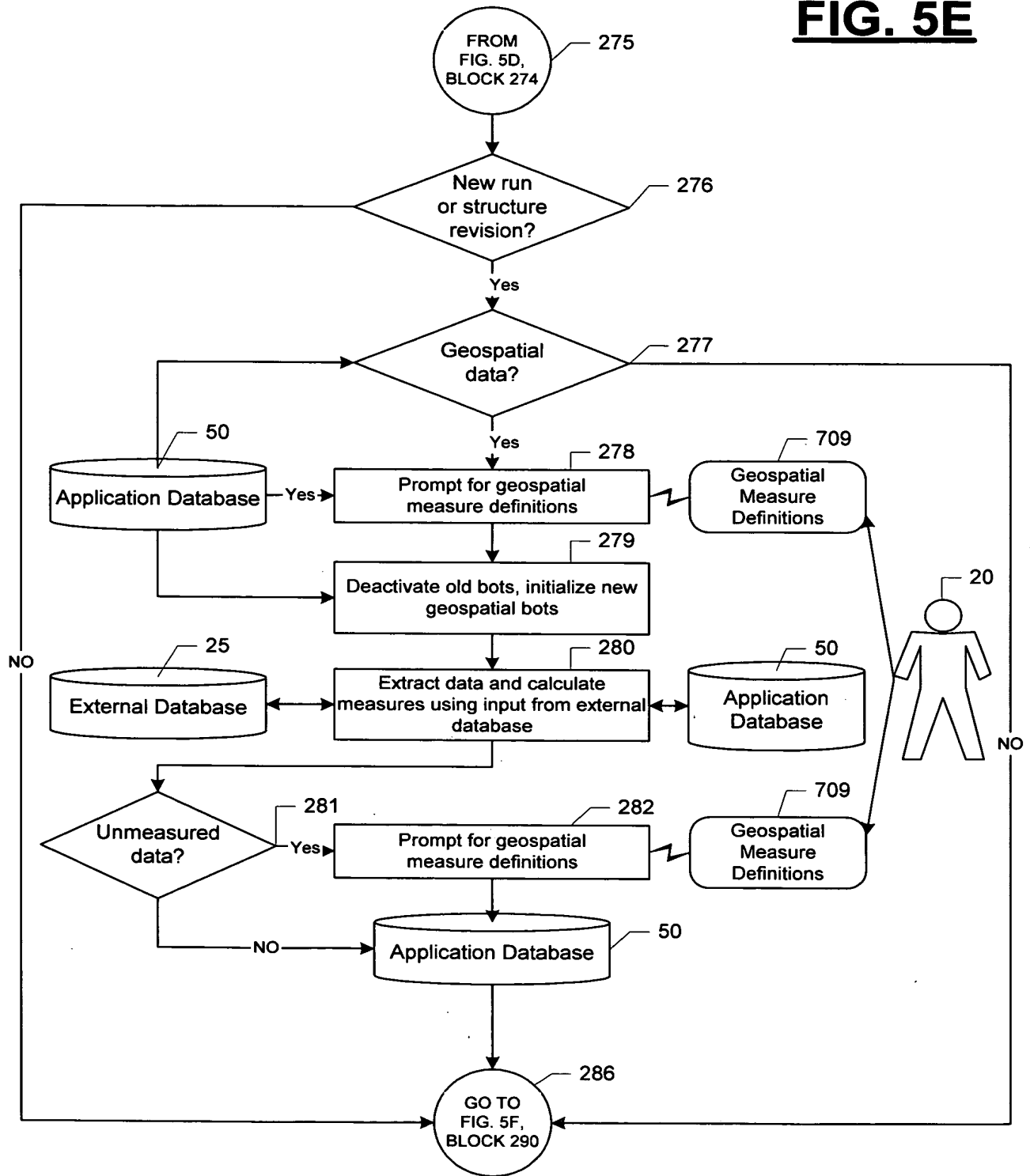


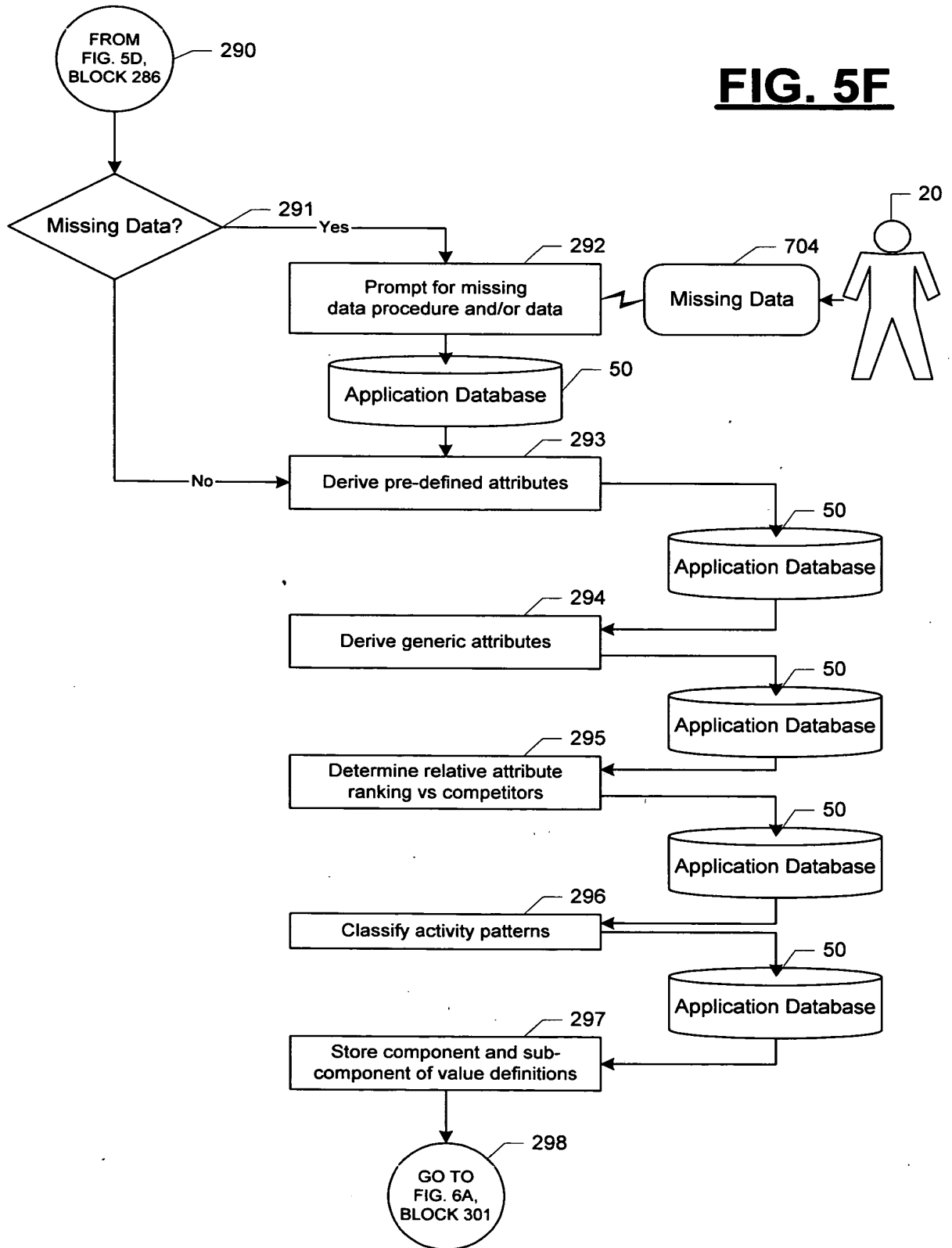
**FIG. 5D**



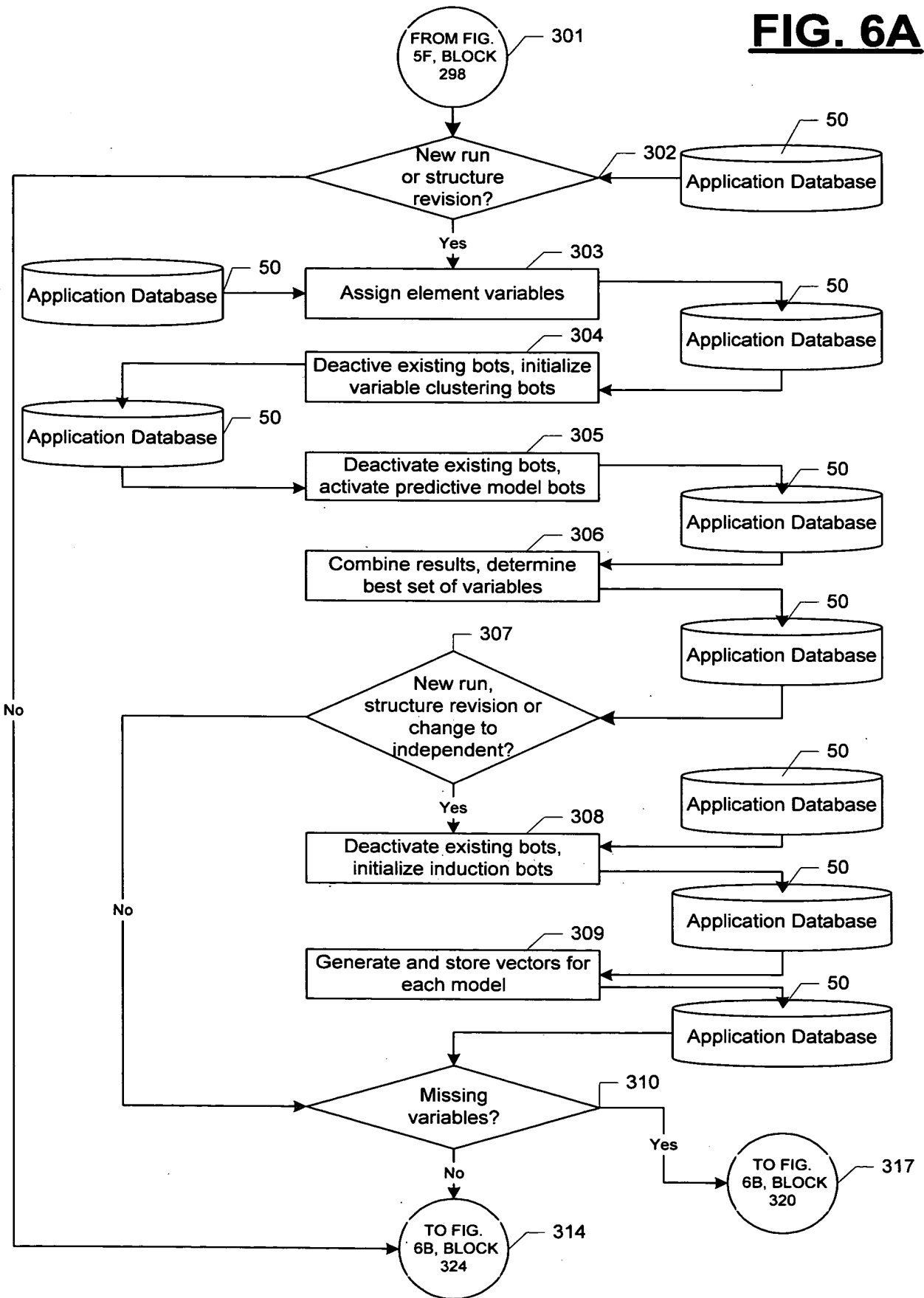


**FIG. 5E**

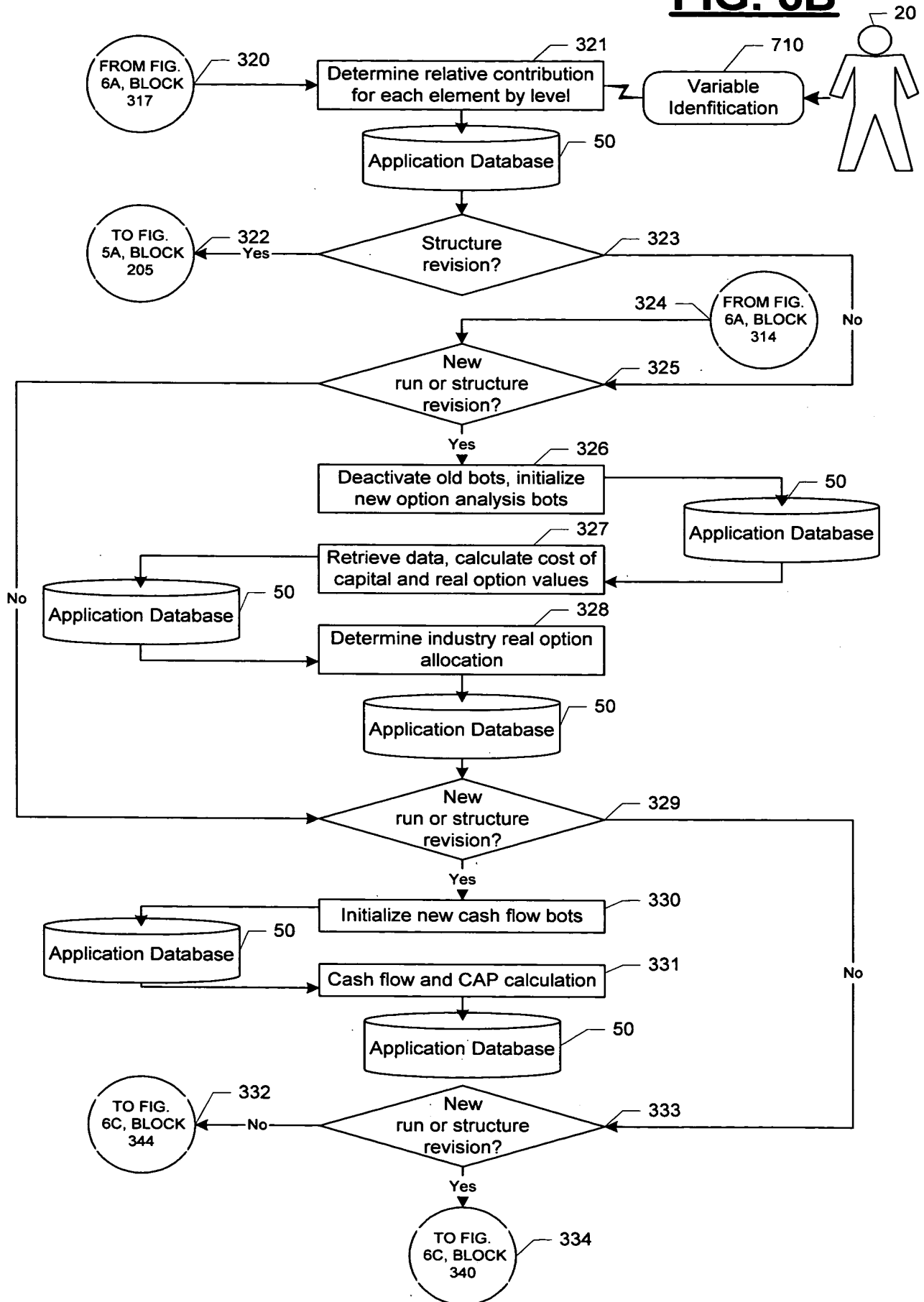




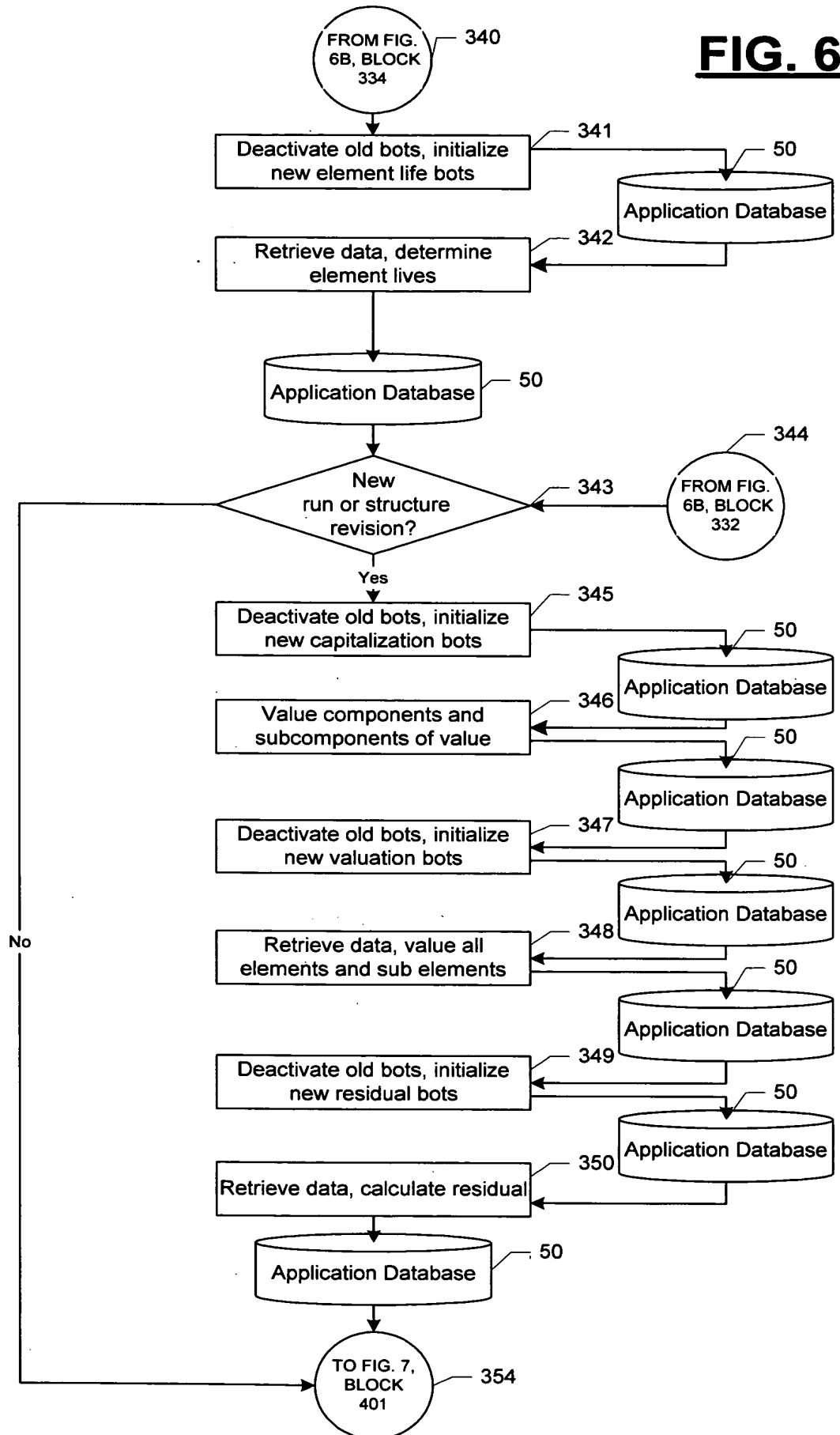
**FIG. 6A**



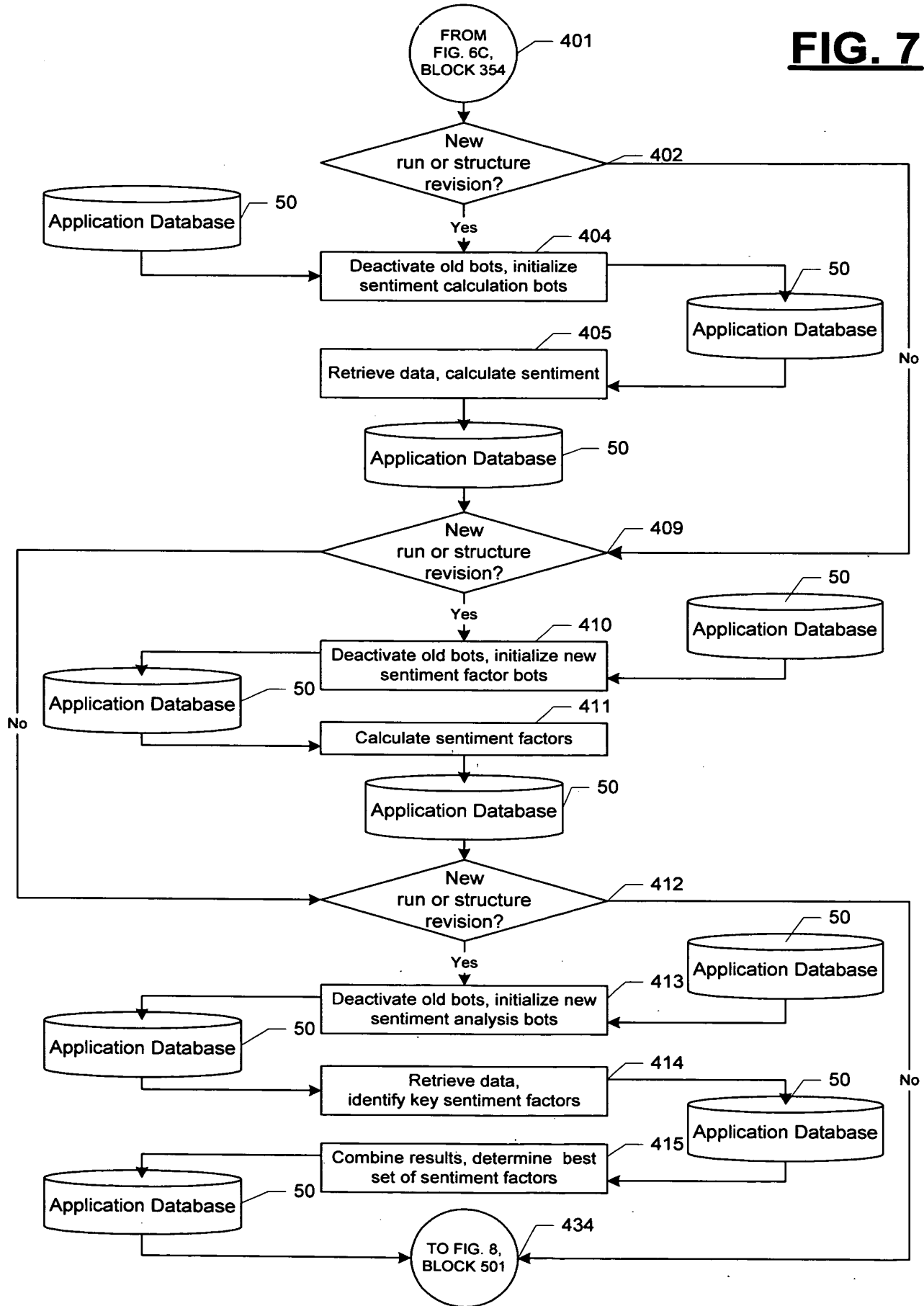
**FIG. 6B**



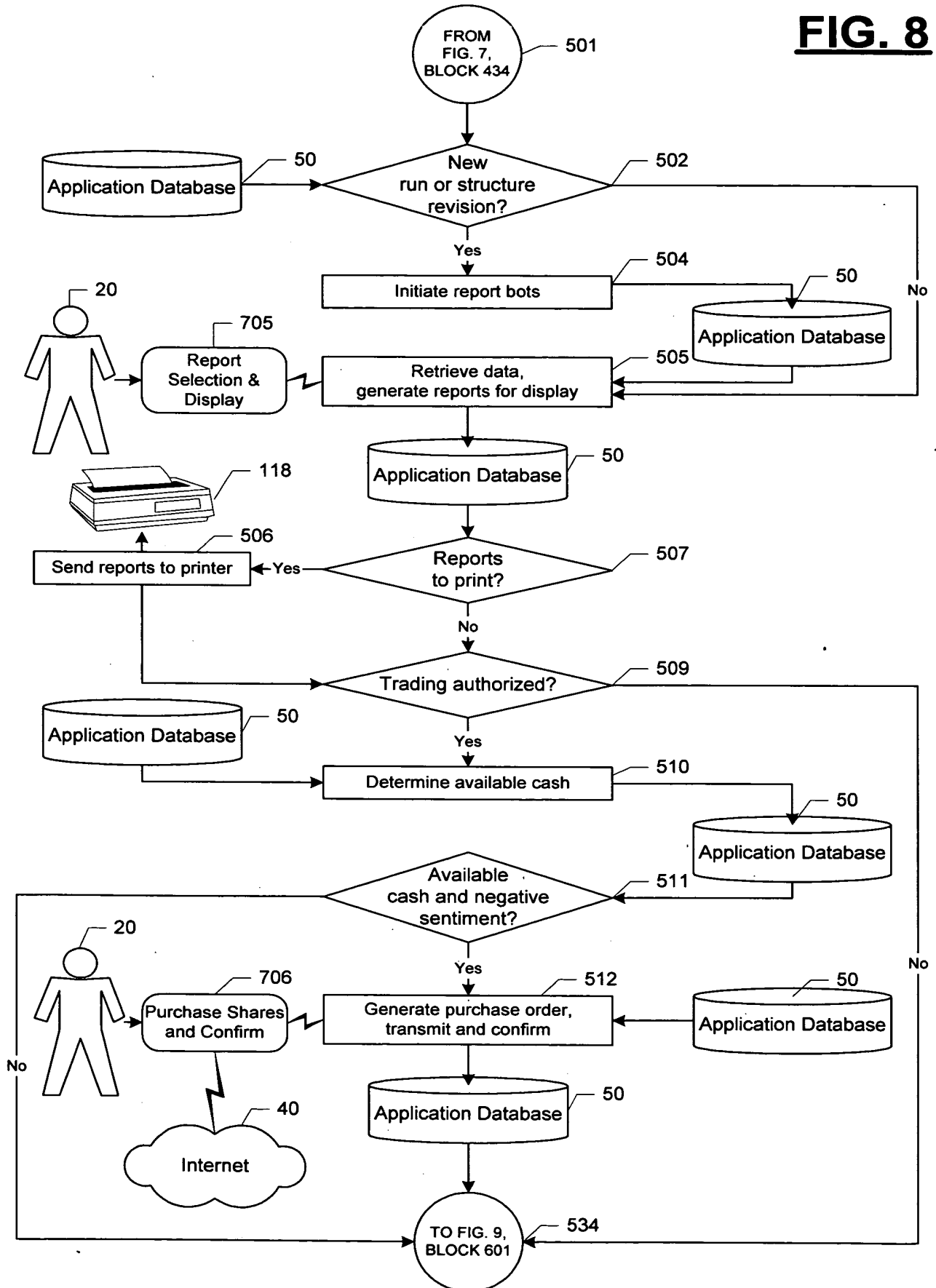
**FIG. 6C**



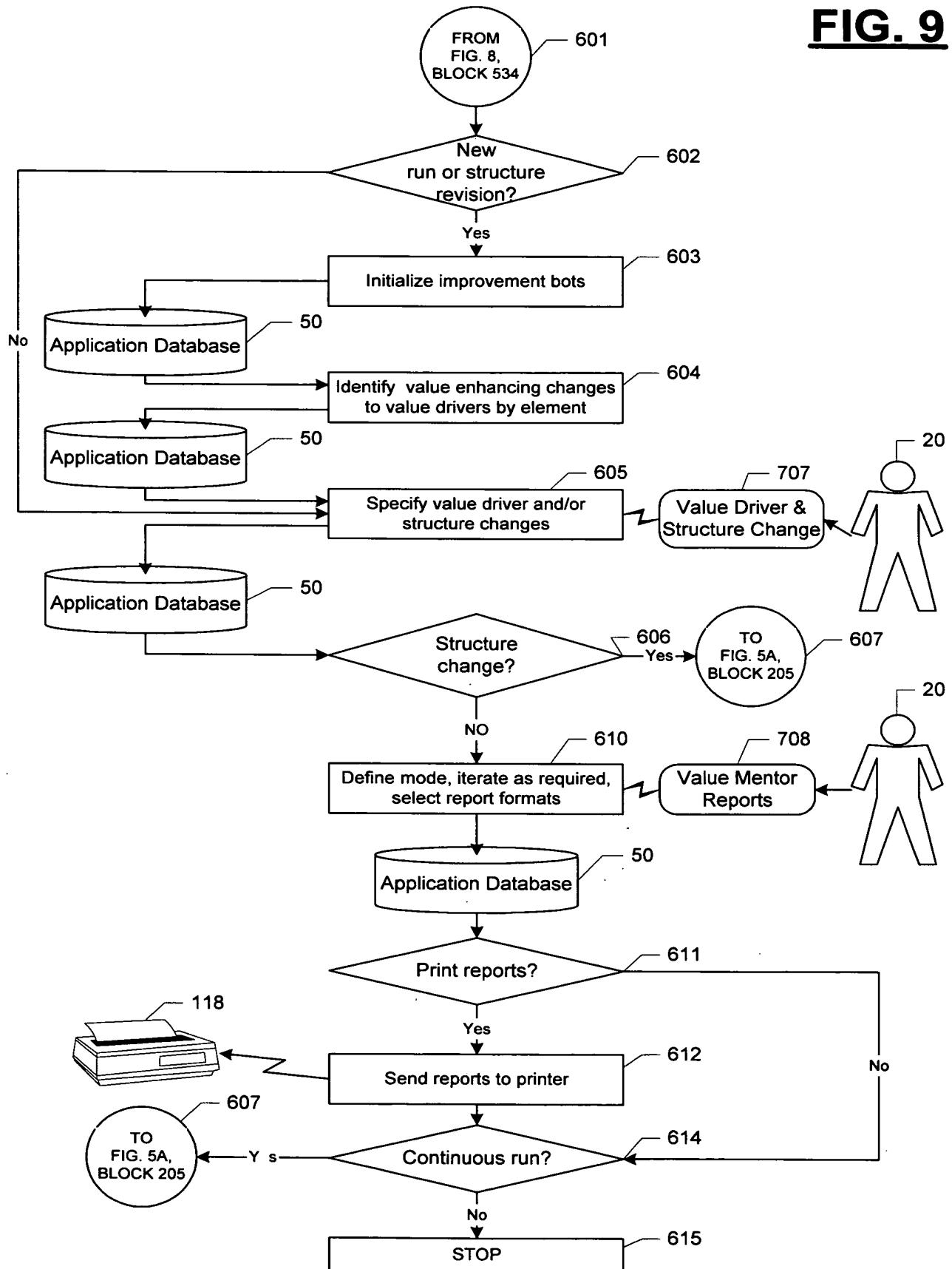
**FIG. 7**



**FIG. 8**



**FIG. 9**





**FIG. 10**

**INPUT  
VARIABLES -  
711**

**INPUT WEIGHTS -  
716**

**INPUT  
LAYER - 712**

**OUTPUT  
LAYER - 713**

